



MAXIM[®]

Outdoor Wood Pellet Furnace



26% tax credit*
on qualified models &
installation

THE OUTDOOR ADVANTAGE[®]

Heat your entire home and domestic water. The Maxim outdoor wood pellet furnace can be installed safely outdoors next to your home.

*US Internal Revenue Code Sec. 25(D) effective Jan. 1, 2021, for heating a residence. Information provided here as a convenience and may not be relied upon as substitute for professional tax advice. Consult a tax professional with any questions.

The Maxim M255 PE is EPA Step 2 Certified.

CentralBoiler.com

Welcome to the best way to heat with wood pellets. Welcome to Central Boiler.



FREEDOM TO DO MORE The Maxim outdoor wood pellet furnace features a large integrated hopper (it can hold up to twelve 40-lb bags of wood pellets!). Combined with a controller that allows the fire to go out if there is no call for heat and electric ignition that will relight it automatically when needed, you'll have more time to do the things you want to do.



GET IN YOUR COMFORT ZONE The Maxim gives you whole-home comfort, not just one room. Because it uses your existing heating system to deliver the heat, you can set the thermostat where you want in different rooms, or you can heat other buildings like your garage.

You can even enjoy unlimited hot water for showers or baths while turning your water heater off.



PEACE OF MIND Keep the fire outside and it eliminates the traditional indoor stove hazards. Burning indoors is inherently dangerous as there is a threat of a fire and carbon monoxide buildup.



IMPROVED INDOOR ENVIRONMENT The mess stays outside with a Maxim outdoor wood pellet furnace. Anyone that has ever heated with an indoor pellet stove is familiar with the smoke, dust, ashes, odors and soot that often occur.

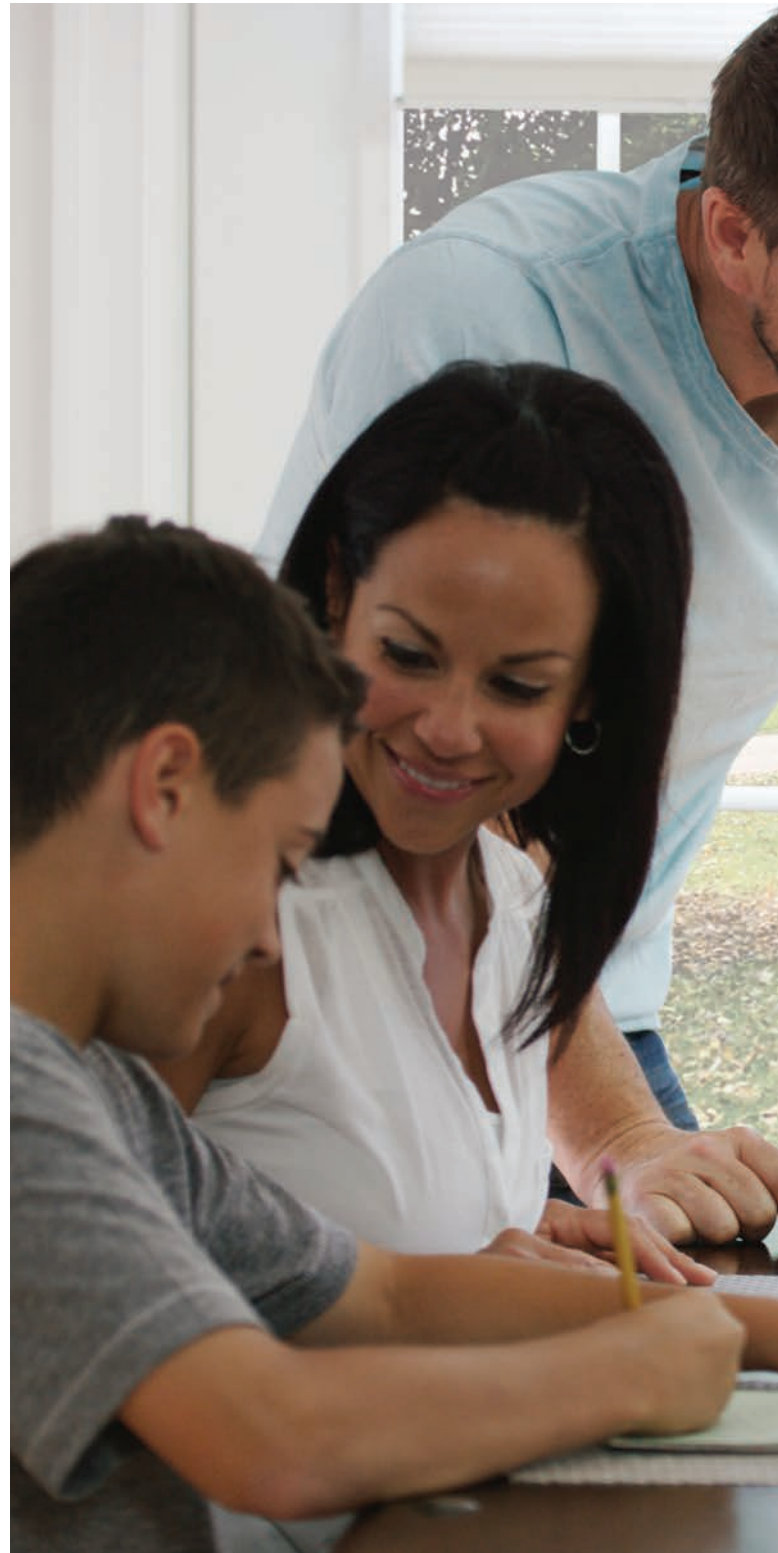



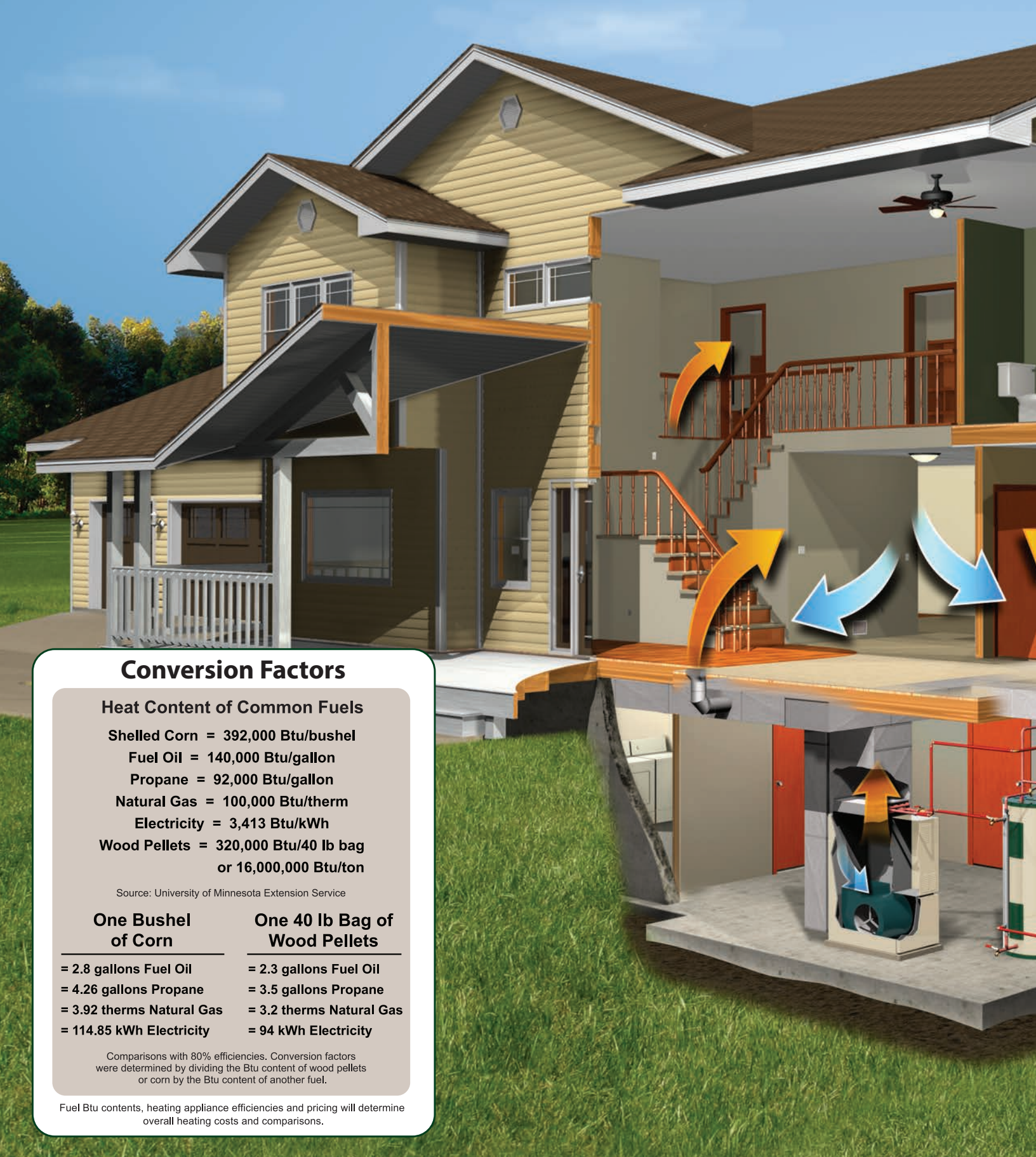

Conversion Factors

Heat Content of Common Fuels

- Shelled Corn = 392,000 Btu/bushel
- Fuel Oil = 140,000 Btu/gallon
- Propane = 92,000 Btu/gallon
- Natural Gas = 100,000 Btu/therm
- Electricity = 3,413 Btu/kWh
- Wood Pellets = 320,000 Btu/40 lb bag
or 16,000,000 Btu/ton

Source: University of Minnesota Extension Service

One Bushel of Corn

- = 2.8 gallons Fuel Oil
- = 4.26 gallons Propane
- = 3.92 therms Natural Gas
- = 114.85 kWh Electricity

One 40 lb Bag of Wood Pellets

- = 2.3 gallons Fuel Oil
- = 3.5 gallons Propane
- = 3.2 therms Natural Gas
- = 94 kWh Electricity

Comparisons with 80% efficiencies. Conversion factors were determined by dividing the Btu content of wood pellets or corn by the Btu content of another fuel.

Fuel Btu contents, heating appliance efficiencies and pricing will determine overall heating costs and comparisons.



Installing your Maxim outdoor furnace is easier than you might think. Many customers choose to install their own furnace because the installation can be easily completed using the installation manual. Authorized Maxim dealers have all the supplies and accessories you need for installation and maintenance. All of our dealers can provide you with information regarding your installation, and most dealers can even handle the entire installation for you.

So simple to install, so simple to use.

How a Maxim outdoor wood pellet furnace works.

While a Maxim outdoor wood pellet furnace is one of the most technologically advanced ways to heat with wood pellets, how it heats is a pretty simple idea. A Maxim outdoor furnace burns wood pellets to heat water. The heated water is circulated through insulated underground pipes called ThermoPEX to the buildings being heated. Heated water can transfer its heat energy by direct circulation or by moving through one or more heat exchangers, or both.

LOCATION The Maxim outdoor furnace is located outside as far as 500 feet away.

CIRCULATION The furnace contains a high volume of water that surrounds the furnace firebox and heat exchanger. This heated water is circulated to buildings through insulated underground pipes which is a highly efficient way to move heat over distances.

INTEGRATION Maxim outdoor furnaces are designed to work with your existing heating system. Water-to-air or water-to-water heat exchangers or direct circulation conveys the heat into the structure's forced-air furnace, radiant baseboard or radiant floor heating system. This allows you to control the heat simply with your thermostat.

UNLIMITED HOT WATER When you install a heat exchanger on your domestic water heater, you can enjoy unlimited hot water and the savings from turning your water heater off.

HEAT MULTIPLE BUILDINGS Unlike an indoor wood stove, a Maxim outdoor wood pellet furnace has the ability to heat multiple buildings such as a house, garage, workshop, shed, greenhouse or barn. It can even be used to heat a swimming pool or hot tub.

Installation is a breeze.

Connect the piping and heat exchangers to your existing heating system and the Maxim is ready to go to work.

Find additional information about how outdoor furnaces work, installation scenarios, and more at CentralBoiler.com

Engineered to the highest standards...ours.

A Easy Installation

Simply set the Maxim in place, connect the piping to your existing heating system, and the Maxim is ready to go to work.

B Easy to Load with Large Integrated Hopper

Large, top-loading door gives easy access to the hopper. Holds up to 12 bags of wood pellets which allows the furnace to heat for days on a single fuel load. Increase fuel capacity even more by adding the optional 48-bushel hopper.



C Convenient Operation

Based on your personalized needs, the **FireStar™ II electronic controller** automatically controls the water temperature, heat output and air settings. Starting the fire is as easy as pushing a button with the automatic electronic ignition..

D Use Less Fuel

A hallmark of Central Boiler furnaces for over 30 years, **spray-on urethane** is the **ultimate airtight, waterproof** insulation that locks the heat in to reduce fuel usage, even at temperatures of -35°F or colder. It provides 2-3 times the effective **R-value** of conventional fiberglass batt insulation. Fiberglass batt insulation also settles and compresses over time.

ELECTRIC IGNITION

Saves Fuel

When there is no call for heat, the controller stops adding fuel and the fire goes out. When there is a call for heat, the controller automatically relights the fire if needed.



Comparing Insulation

	Urethane	Fiberglass Batt
Waterproof	✓	-
Airtight	✓	-
Effectively covers all surfaces	✓	-
Maintains R value	✓	-
Higher R value	✓	-
Doesn't compress	✓	-



E Durability and Reliability

Maxim furnaces are manufactured with attention to detail. From its **sealed and permanently lubricated gear drive** (no chains or sprockets to worry about) to the **aerator** in the burn chamber that agitates the fuel and adds oxygen to the center of the fire, every component must meet the highest standards...ours.



F Easy Inspection and Maintenance

Pumps and the inner components of the Maxim are all easily accessible. The **high efficiency heat exchange system** is designed to require less maintenance and is easily accessible with the removable rear exhaust cover.



Central Boiler's Research and Development department is home to one of the most complete state-of-the-art testing laboratories in the industry. Since 1984, its goal has been to develop, engineer, test and refine a wide range of quality heating products to ensure Central Boiler quality, performance and value are in every outdoor furnace manufactured.



Sample Applications

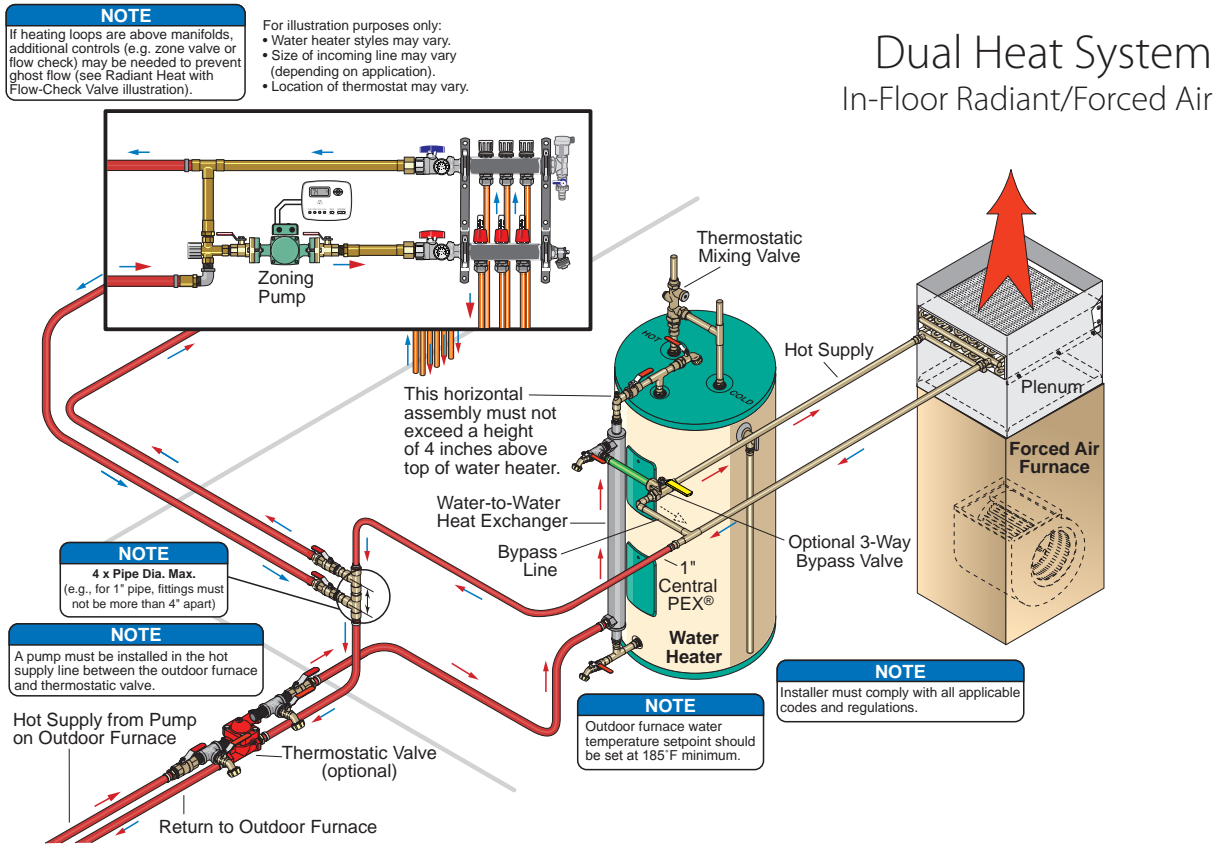

Heating Multiple Buildings

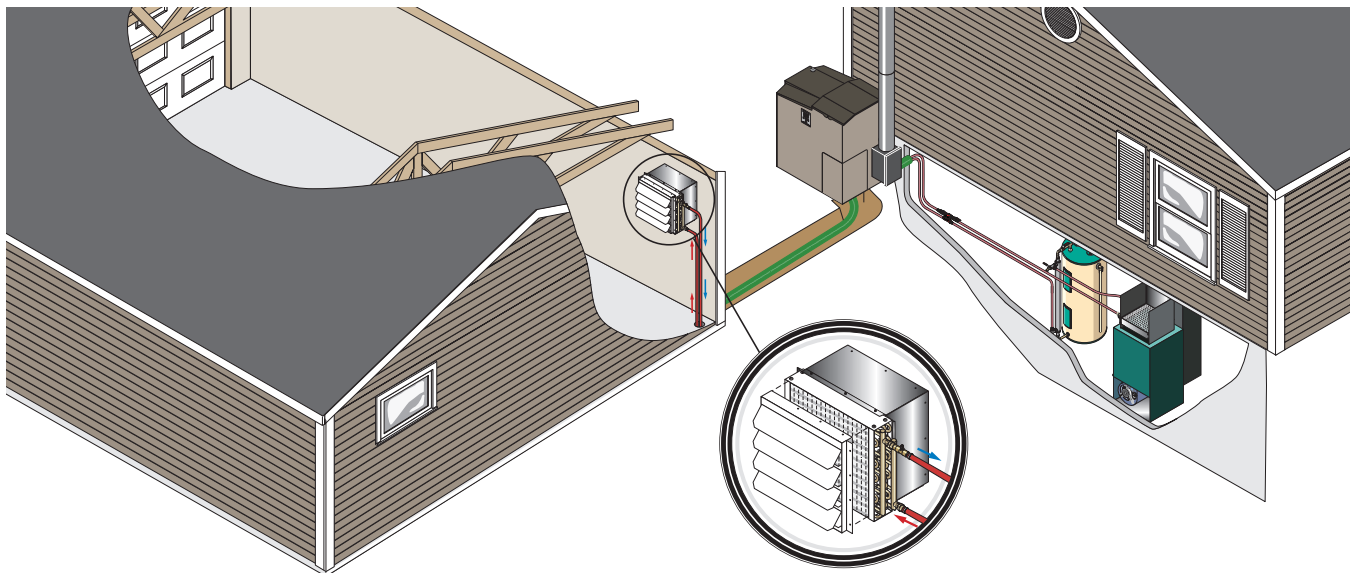

Multi-Zone In-Floor

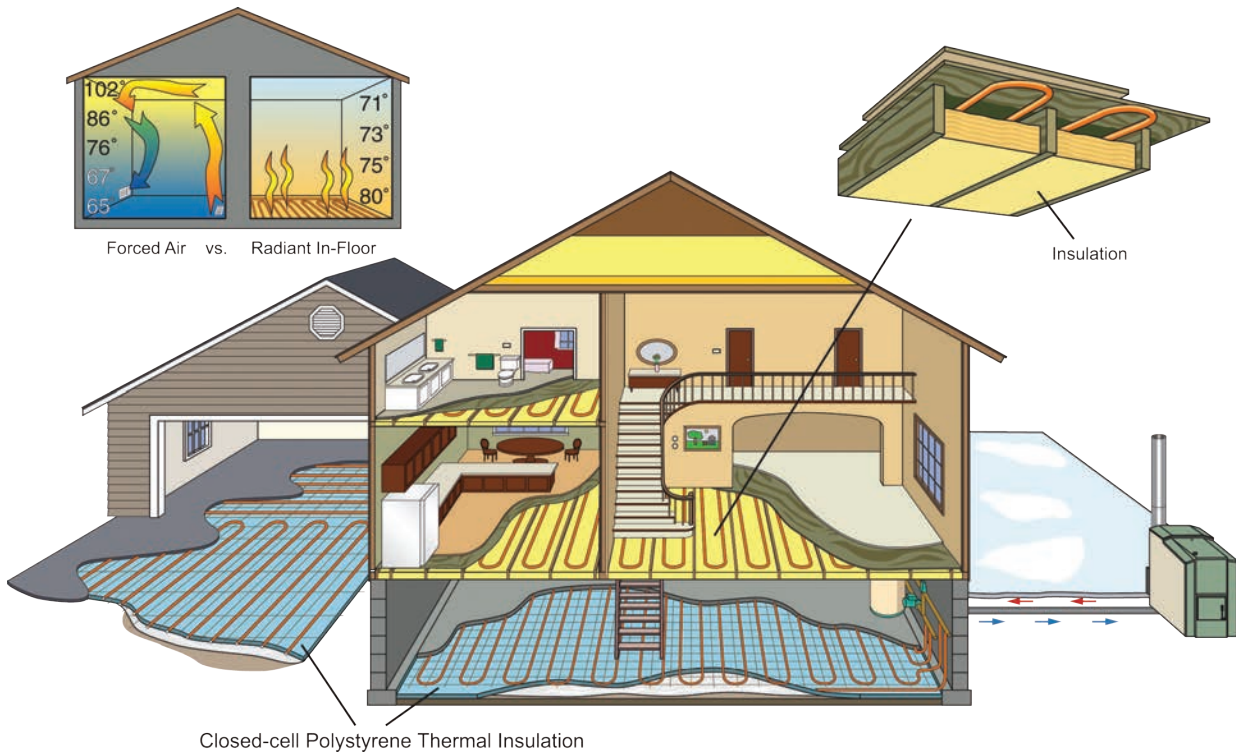

Multi-Zone In-Floor

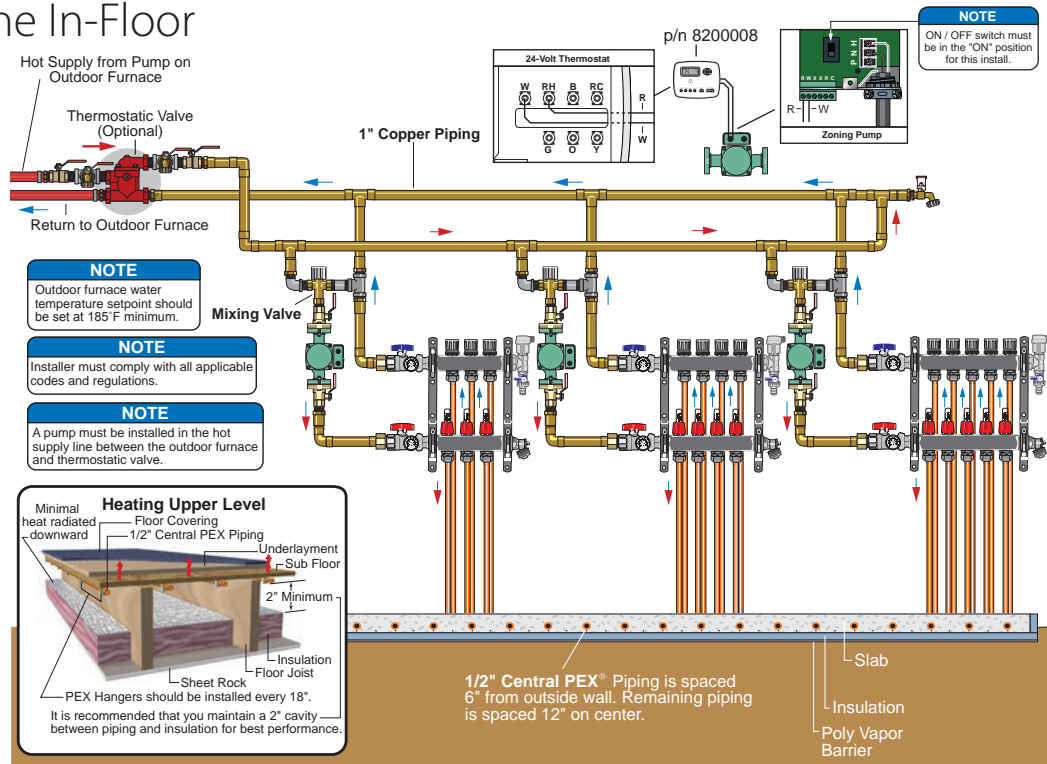

Find more applications at CentralBoiler.com



ThermoPEX[®]

Insulated Piping System



Choose ThermoPEX. Because performance matters.

Choosing the best insulated piping system for your outdoor furnace is imperative if you want to lower heat loss and reduce the amount of fuel you'll burn. The ThermoPEX insulated piping system from Central Boiler is a proven system that saves energy and maximizes the efficiency of your outdoor furnace.

ENERGY EFFICIENT – ThermoPEX saves energy and maximizes efficiency. The thick waterproof jacket keeps moisture out and the inner urethane insulation locks the heat in. Greater system efficiency maximizes the delivery of heat so you will burn less fuel compared to a system using inferior insulated piping.

FLEXIBILITY – Easy to work with, easy to install.

RELIABILITY – ThermoPEX is a proven, time-tested insulated piping system.

INSTALLS FAST – Easy to handle and easy to install, requiring only a narrow trench approximately a foot deep.



IN A HURRY? Some ThermoPEX can be UPS shipped - see dealer for details.

Maxim M255 PE

Overall Efficiency* (LHV) - 96.2%
Overall Efficiency* (HHV) - 89.2%
Mfr's Rated Heat Output Capacity -
 190,000 Btu/hr

Door 15.5" x 13.5"
 Weight 1310 lbs
 Water Capacity 90 gal.
 Hopper Capacity 11 bushel (600 lb)

Included with furnace: Water Test Kit, Cleaning Rod, Flue Brush Kit, Ground Rod Kit, Ash Scoop, Rain Cap and two 4-foot chimney sections



GREEN / OLIVE GRAY



TERRA BROWN / TAUPE
(textured finish)

Furnace Base Dimensions

Optional Hopper Base with Furnace Base

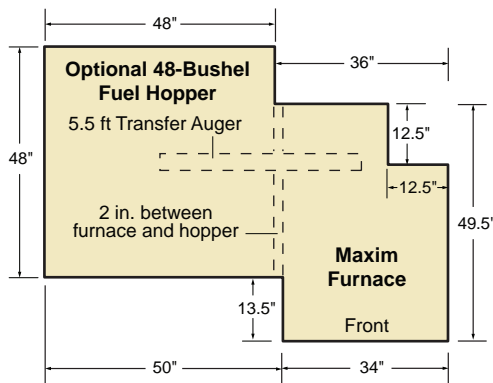
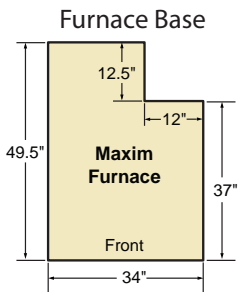

OPTIONAL 48-BUSHEL EXTERNAL HOPPER

Increase your fuel supply (and the days your Maxim will heat) with an optional transfer auger and an optional hopper that can hold up to 2,440 pounds of wood pellets.

NOTE

Furnace must be installed on a noncombustible surface or foundation that incorporates an enclosure that will prevent supply and return lines from possible exposure to sunlight, fire, or physical damage that may be caused by an occurrence outside the furnace enclosure.

CAUTION

Do not use any combustible materials for the foundation.

*Efficiencies are determined under the same test conditions using higher heating value, lower heating value and overall efficiency. The Maxim M255 PE is EPA Step 2 Certified.

LEADERS IN PRODUCT QUALITY, DESIGN AND INNOVATION

Central Boiler traces its roots back to 1984 in a workshop just south of Greenbush, Minnesota. There, a single idea and some welded pieces of metal would grow into a company that is recognized today as North America's largest manufacturer of outdoor furnaces. The company's innovations and patents come from people who take a little more time, pay a little more attention and go a little further to make sure that every Central Boiler product is ready to meet the demands of the real world.

AUTHORIZED MAXIM DEALERS LOCATED ACROSS THE U.S. AND CANADA

When you're looking for a wood pellet heating system, a Maxim dealer is there to answer questions, provide you with literature about Maxim outdoor furnaces and help you choose the model right for your heating needs.

To locate a Maxim dealer in your area, visit the dealer locator at **CentralBoiler.com**.

The Maxim M255 PE is EPA Step 2 Certified.

20502 160th Street • Greenbush, MN 56726

(800) 248-4681 or (218) 782-2575

CentralBoiler.com

© 2022 Central Boiler

®™ Trademarks of Central Boiler, Inc.

Printed in the United States 3/22

For the maximum performance and life of your furnace, always insist on using Central Boiler authorized system parts and accessories.

See Owner's Manual for proper chimney height and installation. Minimum chimney height is determined by proximity to other buildings. Consider location and direction smoke may travel with prevailing winds before installing your furnace.

Content of this brochure is information in possession of Central Boiler at the time of the design of this publication and may not represent what was previously manufactured. Product specifications and appearance subject to change.

Operating an outdoor furnace may not be suitable to some individuals' abilities or lifestyles. Be sure to review the Owner's Manual for the appliance with your dealer.

Must be installed in accordance with all applicable codes and regulations.

Ask your dealer about Outdoor Furnace Best Burn Practices.

p/n 9000934 • Rev. A



All installations and operations must be in accordance with local and state codes which may differ from the information in this brochure.



FREE 5 YEAR LIMITED WARRANTY

A **free 5 year limited warranty** is available if your Maxim is registered at the time of purchase. Central Boiler leads the industry with its commitment to stand behind its outdoor wood furnaces. See Warranty Registration form for details.

Your Authorized Maxim Dealer